

# Robustness of Radio Link Between AAU-Cubesat and Ground Station

Lars Alminde, Morten Bisgaard, Dennis Vinther, Tor Viscor and Kasper Z. Østergaard

**Abstract.** The AAU-Cubesat is to become one of the first pico-satellites to be launched into space. The most critical subsystem of the satellite is the communication subsystem, which must ensure that it is possible to transfer telemetry and telecommands between ground station and satellite without data errors.

This paper is a theoretical study of the radio link that will be established with the AAU-Cubesat when launched. In this paper the hardware and software protocols that make up the communications system will be analyzed in terms of error detection and correction abilities, and the physical radio-link is described.

This analysis is used to implement a **simulink** model of the complete system, and this model is used to estimate the baudrate of errorfree payload data that can be sustained for various scenarios.

The results from the simulations are discussed and it is concluded that the simulations indicate that the chosen design for the communication system is able to provide the required bandwidth of errorfree data transfer.

## 1 Introduction

The AAU-Cubesat project aims to send a satellite with dimensions 10x10x10 cm and mass one kilogram into Low Earth Orbit. The mission of the satellite is to take pictures of the surface of the Earth, using the on-board CCD-camera, and download these pictures to the ground station situated at Aalborg University in Denmark. The satellite is solely designed and built by students.

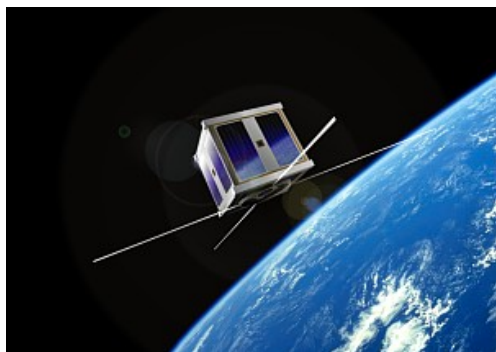

Figure 1. An artist's conception of AAU-Cubesat in orbit

One of the critical subsystems of the satellite is the communication subsystem, which must ensure that it is possible to

reliably send data to and from the satellite, i.e. without undetected errors. The purpose of this research article is to clarify the degree of transmission robustness, i.e. ability to detect errors, of the link between the ground station and the satellite.

While satellite communication system has been used for many years, it has never before been attempted to launch a satellite as small as the cubesat concept requires that employs a fully independent communication system. The AAU-Cubesat will be among the first cubesats out of approximately 20 ongoing projects to be launched within the next half year. There are therefore no sources of direct comparable research within this field.

However Stanford university has launched several satellites in the 20 kg class, and has demonstrated that it is possible to make reliable communication systems for this class of satellites that transmit with a power of about 1 Watt at a data rate of up to 9600 baud using the AX25 protocol for data-link management [7]. Further if one looks at the currently ongoing cubesat projects they generally use about one watt of output power while limiting the data rate to 1200 baud. For link management they use either the AX25 protocol or the Simple Radio Link Layer (SRL) protocol [8].

The communication system on-board the AAU-Cubesat satellite consists of:

- AX25 amateur packet radio protocol in software
- Mobitex packet encoding using MX909 single chip modem @ 9600baud
- Radio operating at 437.9 MHz transmitting 0.5 watt, half duplex
- Two perpendicular dipole antennas, gain approximately 0 dB

On the ground station the AX25 protocol and MX909 modem are the same as used on-board the satellite, but the radio transmits at up to 75 watts and the antenna consists of two crossed yagis each with 16 elements providing a receiver gain of approximately 16 dB.

The satellite generates housekeeping packets of about 250 bytes each, every 2 minutes. Therefore 176 kB need to be downloaded from the satellite on a daily basis. Control commands to the satellite are in general very short and it is estimated that on a daily basis 5 kB data of data are ample. To fulfill the mission a picture of 1280 kB needs to be downloaded each day.

The above means that approximately 1461 kB needs to be transmitted every day. It is estimated that the satellite will be within radio contact 5 times for approximately 12 minutes each a day. Then the research hypothesis can be formulated as:

*The combination of the AX25 protocol for link management and the Mobitex packet format for transmission of telemetry and telecommand packets between the AAU-Cubesat and the ground station will ensure reliable communication at a rate that allows*

## downlink of a picture and log and housekeeping data within 60 minutes

In this paper the AX25 protocol and Mobitex frame format will be described in terms of error detection and correction abilities. A link budget analysis will be presented for the physical radio link. Then a model, made using Simulink<sup>1</sup>, of the communication system will be presented and simulation results from the model will be analyzed in order to see if the above hypothesis holds.

After the 25th of April when the satellite has been launched into orbit the actual performance of the communication subsystem will be compared to the results concluded from this paper.

In the following at first the theory behind the communications system is described. Then a simulation model is developed and simulations are carried out. Finally results are discussed and the conclusion made.

## 2 Theory

This section will analyze the various elements of the communication system and derive analytical expressions for the elements' abilities to detect and/or correct errors. Further the physical radio link will be analyzed in order to derive numbers describing the signal loss due to signal propagation and numbers describing the amount of noise that affects the signal during transmissions.

In figure 2 a general overview of the communication system is given.

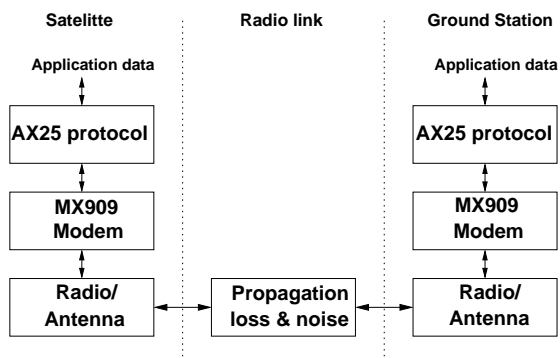

Figure 2. A general overview of the communication system

Examining the figure, it is clear that the communication system is conceptually the same on the satellite as at the ground station. There are however, differences in hardware as will be described during the paper. The following paragraphs will elaborate on the various block of the figure.

The application data, i.e. the actual data to be transmitted through the link, is first passed to the AX25 protocol which is responsible for link management. In effect the AX25 protocol implements the second layer of the OSI model [5]. This layer will output frames of up to 240 bytes of data to the modem. The AX25 protocol attaches additional overhead information to each data-packet in order to detect transmission errors and in order to do link management.

The modem generates a baseband signal that is modulated onto the carrier wave by the radio. Therefore in effect, the mo-

<sup>1</sup> Part of the Matlab package

dem and radio corresponds to the physical layer of the OSI-model, i.e. layer 1. In addition the MX909 modem hardware encodes the incoming frames from the AX25 protocol in packets of 18 bytes before transmission through the radio. These packets are encoded with mechanisms in hardware that will help detect and correct errors when the data are received at the other end of the link.

After the signal leaves the radio the signal strength at the receiver is determined by a large number of variables: antenna gains, antenna orientation, signal amplification, atmospheric conditions, distance, etc. In addition noise is introduced because of noise in the receiving equipment and external radio disturbances. These effects will be analyzed in order to derive a link budget.

### 2.1 AX25 Link Management Protocol

A detailed description of the AX25 protocol is beyond the scope of this paper, and the following will emphasize the mechanisms of the protocol that are relevant in terms of error detection and correction. For a detailed description of the protocol see the protocol specification [6].

#### 2.1.1 Frame Format

When a connection between two stations is established using the AX25 protocol then data frames are passed back and forth between the two stations. The general frame format used for data transmission is shown in figure 3.

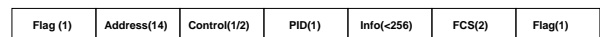

Figure 3. The AX25 frame format where number of bytes are in parentheses

Briefly described the functionality of each field in the frame is:

**FLAG:** Indicates start and stop of the frame

**ADDRESS:** Identifies sender and receiver

**CONTROL:** Identifies the type of frame which in this case is a information frame

**PID:** Identifies the type of top-level protocol

**INFO:** Contains from zero to 256 bytes of data

**FCS:** The frame check sequence which will be described in detail below

#### 2.1.2 Cyclic Redundancy Check (CRC)

The FCS field contains a 16-bit CRC checksum of the data calculated according to the ISO 3309 standard. This checksum is calculated from both the INFO field as well as the non payload non flag fields, i.e.: ADDRESS, CONTROL and PID fields using the following generator polynomial:

$$G(x) = x^{16} + x^{12} + x^5 + 1 \quad (1)$$

Such a polynomial can also be represented as a bit string, where each bit represent the coefficient ( $G(x)$ : 10001000000100001). When calculating the CRC, all arithmetic operations are performed in modulo 2, i.e. as XOR operations for both addition and subtraction.

If the data to be transmitted are represented by the polynomial  $M(x)$  then this polynomial is made divisible by  $G(x)$  by appending 16 bits to  $M(x)$  such that the appended  $M(x)$  is divisible by  $G(x)$ . This new polynomial is called  $T(x)$  and represents the data that is actually transmitted.

The received signal is  $T(x) XOR E(x)$  where  $E(x)$  is the sequence of bitflips introduced to the transmitted signal. When received the division  $(T(x) XOR E(x))/G(x)$  must yield zero in order to pass the checksum test. This test, with the given polynomial (equation 1), will detect the following types of errors ( $E(x)$ ) (see [5]):

- Single bit errors, i.e. one 1 in  $E(x)$
- Two isolated single bit errors, i.e. two 1's in  $E(x)$  with zeroes between
- All instances of  $E(x)$  with an odd number of ones
- Burst errors of up to 16 bits, i.e.  $E(x)$  contains 16 consecutive one's

### 2.1.3 Connection Oriented vs. Connectionless

Having discussed the error detection mechanism in the AX25 protocol, attention will be turned to the link management mechanisms of the protocol. The AX25 protocol provides two distinct methods for data transmission:

- Connection oriented transmissions
- Connectionless transmissions

The first method employs feedback mechanisms to ensure that the transmitted dataframes are received correctly by the receiver, while the second method simply transmits the data without further link management.

The connectionless transmission mode will be used to transmit picture data from the AAU-Cubesat to the groundstation. All other telemetry and telecommands will be exchanged using the connection oriented mode. This latter mode of operation will be analyzed more in detail in the next subsection.

### 2.1.4 Retransmission and Acknowledge

The AX25 protocol specifies that an acknowledge must be sent for each frame containing data, but it is possible to send multiple frames in one window before receiving acknowledge from the receiver. On the AAU-Cubesat however, the window is limited to one frame only due to the limited CPU resources on the satellite. In both cases an acknowledge or rejection is sent immediately by the receiver as a response to each information frame. Rejection will occur if the receiver detects a discrepancy between the received data and the received FCS field of that frame or if the frame received is out of sequence, i.e. it is not expected.

Whenever a CRC error has been detected in the AX25 protocol, the receiver replies with a REJECT frame telling the transmitter to retransmit the current frame. If no error has been detected the receiver will reply with Receiver Ready (RR) in order to signal that it acknowledges the received frame and is ready for the next.

If the transmitter does not receive a REJECT or RR frame it will time out and transmit a RR frame in order to poll the status of the receiver. The receiver must reply to this request with its status, either REJECT, RR or Receiver Not Ready (RNR). In the first two cases communication will resume with either a new frame or a retransmission of the last frame, and in the latter case, the transmitter will wait for a short amount of time and inquire about the receiver status again. This mechanism also ensures that whole or partly lost frames are detected

This scheme ensures that errors detected by the CRC check, or by timeouts will lead to retransmission of the frame in question. Therefore errors due to the radio link will lead to a decrease in effective bandwidth, i.e. the amount of payload data transferred over time.

### 2.1.5 AX25 Protocol Summary

The AX25 protocol has been described very minimalistically here, but all the main mechanisms of data transmission have been described. Frames are sent from transmitter to receiver and each frame must be acknowledged or rejected by the receiver, unless it is sent connectionless. Error detection is handled by the CRC algorithm for bit errors and timers for lost frames. Finally error correction is handled by retransmitting frames and thus transmission errors lead to reduced effective bandwidth.

## 2.2 MX909 Modem

The MX909 modem and its driver software takes the AX25 frames and breaks them up into smaller packets that are better suited for transmission over a possible unreliable wireless link. In addition to breaking up the frames, the MX909 includes extra overhead bytes in order to implement a Forward Error Correction (FEC) scheme, as well as checksumming and sender/receiver synchronization. The data generated by the modem is modulated using the GMSK modulation scheme and sent to the radio.

The Frame Format includes a Frame Head, which contains frame synchronization bytes and the number of bytes in the transmission. This packet is then followed by up to 32 Data Blocks which contain the actual data to be transmitted. This is shown in figure 4.

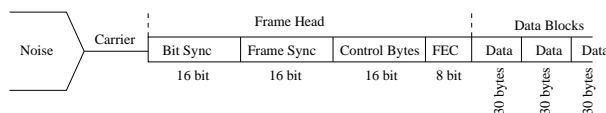

Figure 4. MX909 in air frame structure

The following paragraphs will first describe the FEC mechanism then the Frame Head and Data Block formats will be described.

### 2.2.1 Forward Error Correction (FEC)

For each byte sent the modem generates 4 bits FEC. This makes it possible to correct any single bit error in each block of 12 received bits (8 data and 4 FEC-bits). The matrix used by the FEC is shown in table 1.

FEC code	Parity bits
11101100	1000
11010011	0100
10111010	0010
01110101	0001

Table 1. Forward Error Correction matrix

When a byte is to be sent it is logically ANDed with the 8 bit FEC code from table 1 and thereby generates 4 different parity statements - one for each row in the table. These 4 parity statements are combined and appended to the original 8 bits forming a total of 12 bits including the FEC. An example of this is shown in table 2 where the sequence 11000111 is to be sent.

Table 2 shows that the FEC code is 1001 which makes the resulting bit sequence 11000111 1001 after the FEC code has been appended.

FEC matrix:	11101100	11010011	10111010	01110101
Original byte:	11000111	11000111	11000111	11000111
Result of AND:	11000100	11000011	10000010	01000101
Parity:	1	0	0	1

**Table 2.** Example of how to generate FEC

When the bit-sequence is received the bits are logically ANDed with the 12 bit words from table 1. This forms four new words - one for each row in the table. The parities of these four words are then examined. If there have been no bit flips in the transfer then all the parities will be zero. If there have been bit flips then one or more of the parity bits will be 1. This is shown in an example in table 3. The received word should have been 11000111 1001 but it is 11010111 1001.

FEC	11101100 1000	11010011 0100	10111010 0010	01110101 0001
Word	11010111 1001	11010111 1001	11010111 1001	11010111 1001
AND	11000100 1000	11010011 0000	10010010 0000	01010101 0001
Parity	0	1	1	1

**Table 3.** Detection of bit flips

The parities indicate where the error has been detected. In this case it is in column 2, 3 and 4. To locate the bit flip position in the word it is examined what bit rows 2, 3 and 4 in table 1 have in common and at the same time row 1 does not have. This is done by inverting the rows where the parity bit were 0 and leaving the others unchanged. Thereafter the rows are ANDed as shown in table 4. Had there been no errors all the parity bits would have been 0000.

Row number	Bit sequence
Row 1 inverted	00010011 0111
Row 2	11010011 0100
Row 3	10111010 0010
Row 4	01110101 0001
Result of AND	00010000 0000

**Table 4.** Locating the error

It is evident from in table 4 that the bit flip has occurred in bit position 8. The bit is then flipped back and the 4 extra FEC bits are discarded.

This FEC algorithm can only detect and correct a single bit flip since if there are two or more bit flips they may cancel each others parities. This will result in a situation where the FEC algorithm either does not detect the error or determines the position of the error incorrectly and flips an incorrect bit in the sequence. Therefore it is unwise to depend only on FEC for error detection and correction.

### 2.2.2 Frame Head

Having discussed the error correction abilities of the FEC code we will turn to the packet format used by the MX909 modem. The Frame Head synchronizes the data flow between sender and receiver which is achieved by sending two bytes of bit-synchronization followed by two bytes of frame-synchronization. These synchronization bytes are used for the modem circuits to detect the signal and lock onto it.

The two control bytes, as can be seen on figure 4, are used to transfer the total number of bytes contained in the Data Blocks

that will follow the Frame Head. To correct possible errors in the control bytes the last byte of Frame Head is an FEC byte with 4 bits for each of the control bytes.

### 2.2.3 Data Blocks

Following the Frame Head data is sent in Data Blocks, see figure 4, therefore, the data to be sent is split up in to blocks of 18 bytes each. These blocks are then transformed into Data Blocks by adding 2 byte CRC checksum calculated from the 18 data bytes. Then 4 bits of FEC are added for each byte including the calculated CRC checksum. This brings the total Data Block up to 30 bytes when sending 18 bytes of data.

The CRC checksum is computed using the same 16-bit algorithm as used in the AX25 protocol, see section 2.1.2. But it is worth noting that the data the checksum is calculated on is not as the same for the AX25 protocol and the modem.

To protect the Data Blocks against short noise bursts or signal fades the bits from the Data Block is inserted in a matrix with 12 columns and 20 rows and then sent in air by traversing through each column. This process is called interleaving and is shown in figure 5.

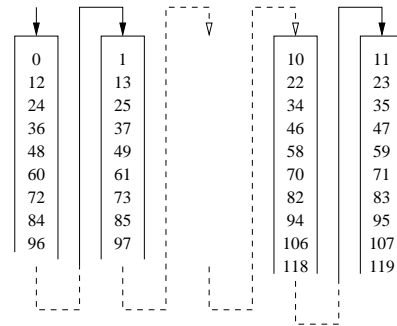

**Figure 5.** Illustration of interleaving.

This means that the bits are transmitted in the order: bit 0, 12, 24, 36 etc. By doing this, the effect of noise bursts is spread out across many bytes and this reduces the number of bit errors that occur in a single byte and this greatly enhances the chance for the FEC algorithm to correct the errors.

### 2.2.4 MX909 Summary

In summary the MX909 modem protocol adds overhead bytes in order to implement a FEC scheme as well as a checksumming scheme that both greatly enhances the ability to detect and correct errors induced by the radio channel.

In addition to the the datahandling described in this paper the modem is also responsible for scrambling, i.e. randomize the output signal in order to better maintain sender/receiver synchronization, and modulation of the signal to be transmitted.

## 2.3 Link Budget

The following will analyze the radio link in order to calculate the amount of errors induced in the datastream by the communication channel at the received end. To this end a link budget must be developed. This budget must take into account the factors that affect the received signal. These include propagation losses, antenna gains, transmitted power, thermal noise at the

receiver, and disturbances through the atmosphere. The overall link budget can be described by the the following function:

$$P_{tx} - l_f + G_{tx} + G_{rx} - L - l_p - N - NF - SNR = 0 \quad (2)$$

where:

$P_{tx}$  is the transmitting power [dBm]

$l_f$  is the signal loss throughout the feedlines of the system [dB]

$G_{tx}$  is the gain factor of the transmitting antenna and feed line [dB]

$G_{rx}$  is the gain factor of the receiving antenna and feed line [dB]

$L$  is the propagation loss [dB]

$l_p$  is the polarization loss [dB]

$N$  is the level of the thermal noise at the receiver [dBm]

$NF$  is the noise figure or sensitivity of the transceiver [dB]

$SNR$  is the signal to noise ratio at the receiver [dB]

All the above variables are in dB or in dBm, with dBm being the power compared to 1 mW in dB. In the following paragraphs, the individual parts of the above shown link budget equation will be explained.

### 2.3.1 Transmitted Power $P_{tx}$

The power transmitted from the transceiver to the antenna is partly transformed into an electromagnetic wave and partly into heat in the antenna. The power lost as heat is given by:

$$P_{heat} = I^2 \cdot R_{electric} \quad (3)$$

The power emitted as radio waves is given by:

$$P_{emitted} = I^2 \cdot R_{electromagnetic} \quad (4)$$

The total power dissipated in the antenna is  $P_{heat} + P_{emitted}$ , therefore the less power that is lost to heat, the more is emitted as a radio wave.

Since the current running through the antenna is the same used in both the emission of the wave and the heat production, a good antenna must have a much greater  $R_{electromagnetic}$  compared to  $R_{electric}$ . In a centre fed dipole antenna, the electromagnetic impedance is  $73 \Omega$  while the electrical impedance is well under  $0.1 \Omega$ . Therefore it can easily be assumed that the heat loss in the antenna is negligible and the full power from the transmitter is emitted as an electromagnetic wave both during up- and downlink.

The downlink transmitted power is determined by the satellite radio, a modified SX-450, which has an output power of 0.5 W or 27 dBm. The transmitted power during uplink is determined by the ground station radio, an ICOM-910H, which has an output power of 75 W or 49 dBm.

### 2.3.2 Feedline Loss $l_f$

Feedline loss is the loss that occurs between the radio and the antenna. For the ground station, the signal between the antenna and the radio must pass through a signal splitter, then through a polarization switch, through another signal splitter, and lastly through a preamplifier. Passing through the feed line, the signal will also pass through a total of 18 meters of cable. For the ground station feed line, this will yield a total loss of:

$$0.5dB + 1.1dB + 0.5dB + 0.2dB + 1dB = 3.3dB \quad (5)$$

On the satellite, the signal between the radio and the antenna must pass through a signal splitter and a balun. This gives for the satellite feed line a total loss of:

$$0.6dB + 0.5dB = 1.1dB \quad (6)$$

This gives a total feedline loss ( $l_f$ ) of  $3.3dB + 1.1dB = 4.4dB$ .

### 2.3.3 Antenna Gain $G_{tx}$ & $G_{rx}$

The antenna gain is a figure for the concentration of the radio waves in one direction. For any antenna that is not omnidirectional, the intensity of the radio waves propagating from the antenna will be concentrated in certain directions. This will give a higher wave density in those directions, and a lower wave density in other directions. An example of this can be seen in figure 6

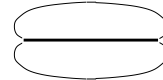

Figure 6. The radiation pattern of a typical dipole antenna

In this example a typical radiation pattern for a center fed dipole antenna is shown. It can be seen that there is no radiation emanating from the ends of the antenna whereas the strongest radiation is emanating perpendicular to the antenna.

When referring to the gain of an antenna, it is the propagation density of the radio wave compared to the propagation density the antenna would have had, had it been omnidirectional.

Since the ground station antenna will be tracking the satellite, it will always be pointing in such a way that the greatest gain is achieved. Therefore it can be assumed that the gain factor of the ground station antenna, in the link budget calculations, will be the maximum gain, in our case 17 dB.

For the satellite, the conditions are somewhat different. Since it is not known initially which way the satellite will be pointing, the gain factor to be used could be the gain factor in any direction. Therefore, both best and worst gains must be taken into consideration. The gain factor of the satellite antenna is at a maximum when the satellite is pointing its camera side and the antenna towards the Earth (see figure 7).

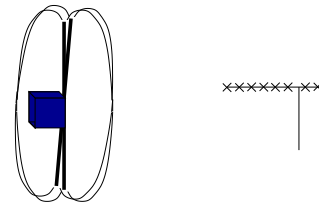

Figure 7. The radiation pattern of the crossed dipole in the best case

Here both dipoles in the crossed dipole array will radiate a strong signal towards the ground station. In this case, the gain factor is 2dB [3]. In the worst scenario the antenna points sideways so that the end of one of the dipoles points towards the ground station (see figure 8).

Here only half of the antenna array will propagate any signal in the direction of earth. Therefore the antenna gain in this case will be -3 dB [9].

### 2.3.4 Polarization Loss $l_p$

The chosen polarization of the satellite and ground station antennas is circular polarization. This means that during optimal alignment (see figure 7), the radio signal will be circularly polarized. When the satellite is not optimally aligned, the polarization will be more and more elliptic until in the worst case (see figure 8), it becomes linearly polarized.

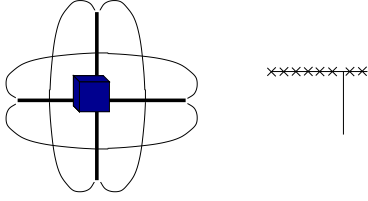

**Figure 8.** The radiation pattern of the crossed dipole in the worst case scenario

Since the ground station antennas at all times are circularly polarized, a loss of signal will occur, when the received signal is differently polarized. This loss is worse when the satellite is aligned so that its antenna is linearly polarized compared to the ground station. In this configuration there is a polarization loss of 3 dB [1].

### 2.3.5 Propagation Loss $L$

Since the radio signal is a series of electromagnetic waves, it propagates through space in three dimensions. Therefore, the intensity of the signal deteriorates as a squared function of the distance travelled. In the context of the link budget, it is assumed, at this point, that the propagation of the radio wave is omni-directional<sup>2</sup>, i.e. it has the same density in all directions. Therefore, the propagation loss  $L$  in dB is found from the following equation:

$$L = 20 \cdot \log\left(\frac{4 \cdot \pi \cdot d}{\lambda}\right) \quad (7)$$

With the satellite orbiting at an altitude of 900 km, the distance between the satellite and the ground station will be a minimum of 900 km. In the worst case when the satellite is just rising above the horizon (see figure 9), the distance between the satellite and the ground station will be 3000 km.

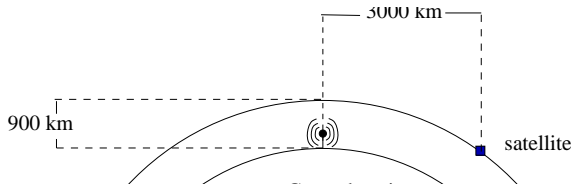

**Figure 9.** An illustration of the distance between satellite and ground station

With a  $\lambda$  of:

$$\lambda = \frac{300.000.000m/s}{437.9MHz} = 0.69m \quad (8)$$

and a worst case distance  $d$  between the satellite and the ground station of 3.000 km, the propagation loss becomes [11]:

$$L = 20 \cdot \log\left(\frac{4 \cdot \pi \cdot 3.000.000m}{0.69m}\right) = 155dB \quad (9)$$

### 2.3.6 Thermal Noise $N$

The thermal noise  $N$  is a figure for the amount of background noise caused by heat-induced molecular movement in the receiving antenna and circuitry. This movement causes noise as

<sup>2</sup> this is a common assumption that allows one to separate the antenna gain and the propagation loss in calculations

soon as the temperature of the material is above 0 K, the higher the temperature, the greater the noise. Also, the greater the bandwidth of the signal, the broader the spectrum of noise that will be detected and therefore, a greater amount of noise power will be present. The noise at a given temperature and a given bandwidth can be found from:

$$N = k \cdot T \cdot B \quad (10)$$

Where:

$T$  is the temperature [K]

$B$  is the signal bandwidth [Hz]

$k$  is Boltzmann constant ( $1.38 \cdot 10^{-23}$ ) [J/K]

In this case during downlink, the receiver will be a low noise preamplifier which is positioned out on a roof by the antenna mast. This means that the temperature will fluctuate during the year between a minimum of 250<sup>0</sup> K and a maximum of 310<sup>0</sup> K. Since the higher temperature gives the most noise, it will be used in the link budget so as to have a worst case scenario. This will give a thermal noise during downlink of:

$$N = 1.38 \cdot 10^{-23} \cdot 310K \cdot 12.500Hz = 5.35 \cdot 10^{-14}mW \quad (11)$$

In dBm this yields the following figure:

$$10 \cdot \log(5.35 \cdot 10^{-14}mW) = -132.7dBm \quad (12)$$

During uplink, the satellite radio will be the receiver. The temperature in the satellite is expected to be between 230<sup>0</sup> K and 360<sup>0</sup> K. Again, the higher of the two temperatures will be used which gives a thermal noise during uplink of:

$$N = 1.38 \cdot 10^{-23} \cdot 360K \cdot 12.500Hz = 6.21 \cdot 10^{-14}mW \quad (13)$$

In dBm this gives:

$$10 \cdot \log(6.21 \cdot 10^{-14}mW) = -132.1dBm \quad (14)$$

### 2.3.7 Noise Figure $NF$

With a given thermal noise at the receiving device, a certain signal strength is required for the receiver to recognise it apart from the noise. The factor between this needed signal strength and the thermal noise of the equipment is the noise figure. During downlink, the receiving device is the low noise preamplifier which has a noise figure of 0.9 dB [4]. During uplink the receiver is the satellite radio which has a noise figure of 17 dB [10]

### 2.3.8 Signal to noise ratio $SNR$

The signal to noise ratio is the ratio between the amplitude of the received signal and the noise received at the receiver. It gives a figure for how clear a received signal is. As the chosen communication is performed using GMSK modulation, the transmitted signal starts as a digital signal which then is modulated into a varying radio wave which again is picked up by the receiving device and is sent on to the demodulator that then demodulates the waves into a digital bitstream again.

The problem arises because the transmitted signal will never be the same as the received signal. Loss through propagation and fading and interference from noise of various origins, will warp the original signal before it is received. If this warping is strong enough, the demodulator will misinterpret the original signal, and some parts of the original digital message will be changed. When this occurs, there is a bit error.

The stronger the original signal, the less it will be affected by the received noise, and therefore, the less bit errors will occur. With GMSK modulation, a typical relationship between the Bit Error Rate (BER) and SNR is shown in figure 10 [2]

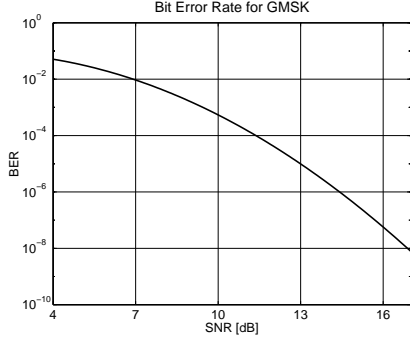

Figure 10. The bit error rate vs. signal to noise ratio

### 2.3.9 Summary of the link budget

With the numbers for downlink inserted in equation 2, the link budget becomes:

$$\begin{aligned}
 27dBm - 4.4dBm - 3dB + 17dB - 3dB &= 155dB \\
 132.7dBm - 0.9dBm - SNR = 0 &\Rightarrow \\
 SNR &= 10.4dB(15)
 \end{aligned}$$

which according to figure 10 gives a bit error rate during downlink of  $3 \cdot 10^{-4}$ , i.e. approximately 1 bit error for every 3000 transmitted bytes. With the numbers for uplink inserted in equation 2, the link budget becomes:

$$\begin{aligned}
 49dBm - 4.4dBm + 17dB - 3dB - 3dB &= 155dBm \\
 +132.1dBm - 17dBm - SNR = 0 &\Rightarrow \\
 SNR &= 15.7dB(16)
 \end{aligned}$$

which according to figure 10 gives a bit error rate during uplink of  $1 \cdot 10^{-7}$ , i.e. approximately one bit error for each 10 million transmitted bytes.

## 2.4 Summary

This section has described the necessary theory to understand and develop the simulation model of the AAU-cubesat communication systems, which will be presented in the next section.

At first the AX25 protocol was described with emphasis on CRC checksumming and frame rejection/retransmission which makes up the error detection and correction mechanisms of the protocol.

Hereafter the workings of the MX909 modem was presented again with emphasis on the error detection and correction mechanisms, which for the modem consists of a forward error correction scheme and CRC checksumming on packets.

Finally the link budget was presented in order to determine the signal attenuation and effects of narrowband noise phenomena.

## 3 Link Simulation

To determine whether the research hypothesis of section 1 holds, a mathematical simulation model is created using Simulink. This model produces the possibility to test the radio link in different situations and thus evaluate the research hypothesis. This is accomplished by examining the following criteria:

1. The link must be reliable in the sense that no erroneous data passes through it from transmitting application to receiving application.
2. The link must be capable of transferring both connectionless picture data of 1280 kB and connection oriented log and housekeeping data.
3. The SNR must be able to deteriorate and still fulfill the 2 points above.

Here the first two criteria will provide information about the quality of the present radio link, while the third criterion will provide information about the performance margin of the radio link.

### 3.1 The Simulation Model

The simulation model consists of 3 major parts: the transmitter, the receiver, and the channel, as shown in figure 11.

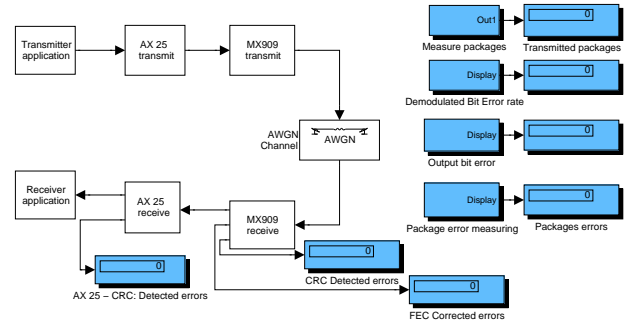

Figure 11. The major parts of the model.

Both the transmitter and the receiver consist of 3 different parts, while the channel model consists of a single block. The separation between channel and transmitter/receiver is placed after the modem, i.e. the radio-units are part of the channel model. The 3 parts of the transmitter and receiver are:

- Application
- AX25
- MX909

The model has been designed as a one way transmission channel from transmitter application to receiver application, which means that for testing the link in both directions a simulation must be made for each direction, i.e. groundstation to satellite and vice versa. However since the only difference between uplink and downlink is the channel model, because both the MX909 and the AX25 layer are the same at both ends, then the same model is used but with different channel parameters. The model itself is frame-based rather than bytestream based. That means, that its inputs and outputs operate on frames of bytes that correspond to the INFO field of the AX25 protocol, see section 2.1.

#### 3.1.1 Measuring Bit Errors

To determine whether a bit error has occurred, measurements are placed at different spots in the model. The measurements are made with a simulink blok that compares two inputs, bit for bit, and outputs the number of erroneous bits.

There are two measurements: demodulated bit error rate and output bit error rate (see figure 11). The first is made on the data just before it is modulated compared to the signal just

after it is modulated. This measurement indicates the number of errors that the channel introduces on the transmitted data. The other measurement is made on the data right after it has left the transmitting application and just before it arrives at the receiving application. This measurement indicates if any bit errors arrive undetected at the receiving application.

### 3.2 Transmitter

The transmitter will generate a bitstream transmitted as frames which are handled by the AX25 and the MX909 and finally, the frames are inserted into the transmission-channel.

#### 3.2.1 Application

The transmitting application can be considered to be either the ground station server software or the data handling system on the onboard computer in the satellite. The application is implemented as a random bit frame generator outputting pseudo-random bit sequences. This is done because of the nature of the majority of the data sent on the radio link. This data is mainly picture data that will change a lot over time since satellite is meant to take pictures of different locations. This means that the data will seem random from the channels point of view, just like the data used in the simulation.

#### 3.2.2 AX25

The AX25 protocol adds a header and footer to the data sent from the applications. The only interesting part of the header and footer, in terms of error detection and correction, is the CRC. Therefore, the AX25 protocol is implemented as a CRC generator for the transmitter and a CRC error detector for the receiver. The CRC generator and CRC error detector are inserted into the model using a standard simulink block.

#### 3.2.3 MX909

The Mobitex protocol is implemented as a series of blocks, since the protocol includes different ways to detect, correct, and prevent errors as described in section 2.2.

The Mobitex protocol is then implemented as a block for each functionality of the Mobitex protocol which is shown in figure 12. When transmitting, a CRC is first calculated then FEC bytes are added and the data is interleaved, scrambled, and modulated according to GMSK.



Figure 12. Illustration of blocks in implementation of the Mobitex protocol in the transmitter

### 3.3 Channel

The channel is modulated using the SNR determined in section 2.3 which is done by using an AWGN (Additive White Gaussian Noise) modulated channel. This is an ideal channel-type which describes the kind of link budget made in section 2.3 and works by simply adding white noise to the signal in respect to a certain SNR, i.e. the result of the link budget, see figure 13.

As described before the channel model contains everything from the transmitting radio to the receiving radio.

### 3.4 Receiver

The receiver retrieves the data stream from the channel and demodulates it and so forth until the actual data is sent to the receiving application.

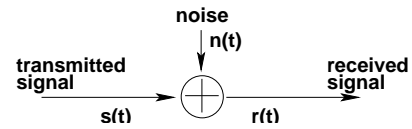

Figure 13. The AWGN channel model

#### 3.4.1 Mx909

The MX909 on the receiver first demodulates the data from a GMSK signal to a bit sequence. Then the data is descrambled and deinterleaved. The FEC decoder then corrects as many errors in the data as possible, removes the FEC code and leaves the rest of the errors untouched. Then a CRC checkum test is performed on the remaining data. For the complete buildup of the receiving signalway see figure 14.

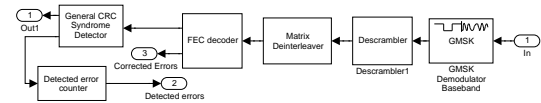

Figure 14. Illustration of blocks in implementation of the Mobitex protocol on the receiver

#### 3.4.2 AX25

The AX25 finally checks the checksum of the entire AX25 frame, counts the numbers of erroneous frames and then removes the header and footer from the data leaving only the raw data to be delivered to the receiving application.

#### 3.4.3 Application

The receiving application is simply implemented as a bit error counter and a frame error counter to determine the number of errors in form of bits and AX25 frames that are delivered through the system. The undetected number of errors can then be determined by subtracting the detected number of erroneous packages found by AX25 with the actual number of erroneous packages introduced in the simulation.

### 3.5 Simulation Procedure

The main objective of the simulation is to estimate the number of retransmissions when sending a picture of 1280 kB using connectionless transfer, as well as satellite log data and house keeping information of 176 kB using connection oriented communication. The number of retransmissions can then be used to tell if the data can be sent within a timeframe of 60 minutes (see section 1) and thus test the hypothesis. This simulation objective will test the link against the criteria one and two stated at the beginning of this section.

The secondary objective is to indicate at which SNR the data can be transmitted within the timeframe. This simulation objective will test the link against criteria one and three stated at the beginning of this section.

Both objectives are tested by calculating the number of retransmissions allowed and then make simulations for the channel using the relevant SNRs for the particular objective.



### 3.5.1 Calculation of Maximum Retransmissions

The maximum number of retransmissions is calculated by first finding the time available for retransmissions and the effective baudrate when sending data including the AX25 acknowledge frames, and then dividing these two numbers. The time available for retransmissions is:

$$T_{retr} = T_{avail} - T_{pic} - T_{loghk} \quad (17)$$

Where:

$T_{avail}$ : is the timeframe available for transmission for one day (60 minutes)

$T_{pic}$ : is the transmission time for a picture (calculated below)

$T_{loghk}$ : is the transmission time for log and house keeping data (calculated below)

In order to calculate  $T_{pic}$ , the effective bandwidth for transmission of pictures must be calculated. This is done by calculating the ratio between the number of data bytes sent in one AX25 frame and the number of bytes sent through the channel (including headers and footers). This ratio is then multiplied by the bandwidth, 9600 baud, to get the effective bandwidth.

The number of databytes sent in one AX25 frame is 256 B. In the AX25 protocol 16 bytes of header and 3 bytes of footer and some bitstuffing is added, giving approximately 288 B sent to the Mobitex layer. The Mobitex protocol splits the data into frames of 18 B and adds 2 B of CRC to each frame. Then it adds 4 bits of FEC for each byte. With  $frac{288}{18} = 16$  Mobitex frames, this makes  $(288+16 \cdot 2) \cdot 1.5 = 480$  bytes sent through the channel. The effective bandwidth when downlinking pictures is therefore:

$$B_{pic} = \frac{256}{480} \cdot 9600 = 5120baud \quad (18)$$

When sending log and house keeping data, each AX25 frame is acknowledged by the receiver. This means that the effective bandwidth for sending this kind of data is lower than the effective bandwidth calculated above.

This bandwidth is calculated by finding the time to download a single AX25 packet (using the effective bandwidth of 5120 baud) adding the delay between when the radio has received the last bit and when it sends the first bit of the acknowledge<sup>3</sup>. Then the time to send an acknowledge is added which is two Mobitex frames giving 60 B at a baudrate of 9600 baud. The time between transmission of two AX25 frames is then  $\frac{256B}{5120baud} + 100ms + \frac{60}{9600} = 550ms$ . This gives an effective bandwidth for log and house keeping data of:

$$B_{loghk} = \frac{256B}{550ms} = 3724baud \quad (19)$$

The time available for retransmissions is then:

$$T_{retr} = 60min - \frac{1280kB}{5129baud} - \frac{176kB}{3724baud} = 1168s \quad (20)$$

### 3.5.2 Criteria Evaluation for Primary Simulation Objective

Since retransmissions only can occur when transmitting log or housekeeping data with the effective bandwidth found in equation 19, it is possible to retransmit  $3724 \cdot 1168 = 531kB$  data which is 2123 AX25 frames. This means that  $\frac{531kB}{531kB+176kB} = 75\%$  of the log and house keeping data can be retransmitted, while still meeting the overall performance requirements.

The main objective can then be tested by simulating the protocols and the channel with the SNR found in section 2.3 and testing if less than 75% of the AX25 frames are retransmissions, i.e. counting the number of CRC errors occurred in the AX25 protocol.

<sup>3</sup> Estimated from time in air calculations and measurements of software latency

### 3.5.3 Criteria Evaluation for Simulation Secondary Objective

The second objective can be tested by varying the SNR of the gaussian channel until 75% of the transmitted AX25 frames are retransmissions. This SNR then indicates the minimum SNR under which the communication system is able to fulfill the requirements. The difference between this SNR and the calculated SNR indicates the margin of error of the communication system.

## 4 Results

In the following the results of the simulations of the primary and secondary objectives are presented. The results are shown in terms of the following points:

**Demodulated BER:** the bit error rate measured from before the GMSK modulation to after the GMSK demodulation.

**FEC corrected errors:** the percentage of errors corrected by the FEC.

**BER at application:** the bit error rate at application-level.

**Detected frame-errors:** the number of frame-errors that is detected by the two CRC-modules.

**Frame-errors at application:** the number of actual frame-errors at application-level.

Four simulations have been carried out for both objectives, each with 176kB connection oriented data equal to 704 AX25 frames including retransmissions for these frames.

### 4.1 Simulation of Primary Objective

In table 5 the results of the simulation of the primary objective are shown. The simulations are carried out with a SNR of about 10.4 dB equal to bit error rate of 0.033%. In average the number of retransmissions are 0.3% which are a factor of about 250 better than the 75% required for adequate bandwidth. Hereby criterion two is fulfilled.

When referring to the criteria of section 3 then it is clear, when comparing the detected frame errors and the actual frame errors at the application level, that no undetected errors passes through the system and therefore criterion one is validated. The radio link must therefore be considered reliable under the present conditions.

Simulation	1	2	3	4
Demodulated BER	0.026%	0.026%	0.025%	0.024%
FEC corrected err.	99.7%	99.7%	100%	98.9%
BER at app.	8.6e-5%	8.6e-5%	0%	2.6e-4%
Detected frame-err.	2	2	0	3
Frame-err. at app.	2	2	0	3

**Table 5.** Simulation-results with respect to the primary objective. Application abbreviated app, and error

### 4.2 Simulation of Secondary Objective

In table 6 the results of the simulation of the secondary objective are shown. The simulations are carried out with a bit error rate of 0.85% equal to a SNR of about 7 dB and a total of 2816 frames. With this SNR the number of retransmission are approximately 75% of 2816 thereby yielding the lowest allowable SNR for the radio-link. Thereby criterion three is fulfilled.

Also under these conditions no frames errors passes through the system undetected and therefore criterion one is also validated under this objective.

Simulation	1	2	3	4
Demodulated BER	0.84%	0.85%	0.87%	0.86%
FEC corrected err.	94.0%	93.9%	93.9%	94.2%
BER at app.	0.066%	0.065%	0.067%	0.065%
Detected frame-err.	2093	2001	2012	2021
Frame-err. at app.	2093	2001	2012	2021

**Table 6.** Simulation-results in respect to secondary objective. Application abbreviated app and error err

## 5 Discussion

The correctness of the results gained from the simulations depend on the accuracy of the model developed for the physical radio-link. The approach taken to model the radio-link builds on previous studies and established methods, and the methods are therefore thought to be well understood and tested. There are, however, a number possible influencing factors that have not been included in the model these and their impact on the radio-link will be discussed in the following.

### 5.1 Multipath Distortion

When the same signal is received from multiple paths, due to radio beam reflections on hard surfaces then we have multipath distortion, which will degrade overall link performance.

However when receiving data from the satellite, the antenna will be actively controlled to point the main lobe of reception towards the satellite, and therefore all reflected signals will be received by the antenna from directions with very little gain. They will therefore have very little effect on the principal signal received from the satellite.

When the satellite receives data from the ground station, there are no reflections since there is a direct line of sight between satellite and ground station.

However, there may be a problem on the satellite itself. The dipoles are situated approximately 5mm – which is a small distance compared to wavelength – above the surface of the satellite and the length of each antenna runs parallel to the surface of the satellite for a small part of the length. This means that the signal that hits the surface will bounce back and then be received again by the antenna with a phase reversal that may to some degree cancel the principal signal. To further investigate this probable problem, tests will be conducted prior to launch in a radio room in order to evaluate the impact of this multipath phenomena.

### 5.2 Presence of Narrowband Noise

As described in the theory section, the Mx909 interleaving process and the checksumming done both at Mx909 and AX25 level ensures reliable communication when the radio-link is disturbed by narrowband noise bursts. However in the presence of a continuous noise source transmitting in the same spectrum, the radio-link will be completely or partly impaired.

This is, however, not likely to become a problem since frequency use is regulated by ITU and specifically the frequency band used by AAU-Cubesat is managed by AMSAT which makes sure that frequencies used by amateur satellites are adequately spaced in order not to interfere with each other even in the presence of doppler-shift.

In addition on the ground station side; the antennas will only be sensitive in the direction of the satellite and they are therefore not very prone to receive the signal from narrowband disturbance sources.

### 5.3 Changing Atmospheric Conditions

The link budget calculated in this paper is calculated for good weather conditions, i.e. a clear sky. The abundance of water vapor in the atmosphere will degrade the performance of the link budget. These effects have not been investigated and the results gained are therefore only valid under the assumption that weather conditions are good.

The impact of this assumption is that on days with bad weather conditions the performance of the radio link will be degraded, possibly below the required data-rate. However as the simulations indicate that the obtainable data-rate on a clear day is much higher than required, then it is estimated, but not guaranteed, that this problem will not have an impact on the requirement to meet the needed data-rate.

### 5.4 Further Research

The three above described phenomena are all good candidates for further research. Another idea for research within this field is a comparative analysis of the radio performance of the first cubesats to be launched. Research based on these missions will provide valuable input to following pico-satellite projects.

## 6 Conclusion

This paper has described a theoretical study of the radio link between AAU-cubesat and its ground station. At first the theoretical background was given by analyzing the physics, hardware, and software involved in the communications system. Thereafter the results of the analysis were put to use in a **simulink** model wherein various scenarios were analysed and results gained.

The results showed that it is possible to transmit a picture as well as log and housekeeping data – a total amount of 1456 kB data – between the satellite to the ground station within a timeframe of 60 minutes. Therefore according to the results of the simulations the research hypothesis is validated.

Further, the results have shown that the link is able to operate under conditions with a signal to noise ratio of at least 7 dB. However the discussion of the results indicated that the results are based on two problematic assumptions, namely, that the results are only valid for clear weather conditions and secondly, that there may be a problem with multipath distortion.

## REFERENCES

- [1] Nicolaj P. Hermansen Janus E. Pallesen, H. Sejere, *DTUSat Ground Station Hardware Theoretical Approach and Design*, Technical university of Denmark, 2002.
- [2] CML ltd., *MX909 Datasheet*, CML, 2002.
- [3] US Navy, 2002.
- [4] SSB, *Super Amp SP-7000 low noise preamplifier*, SSB, 1994.
- [5] Andrew S. Tanenbaum, *Computer Networks*, Prentice Hall, 4 edn., 2002.
- [6] TAPR, *AX.25 Link Access Protocol for Amateur Packet Radio*, TAPR, 2.2 edn., 1997. <http://www.tapr.org/tapr/pdf/AX25.2.2.pdf>.
- [7] STANFORD UNIVERSITY, *Homepage of Stanford small satellite program*, STANFORD UNIVERSITY, 2002. <http://ssdl.stanford.edu/>.
- [8] TOKYO UNIVERSITY, *Homepage of TIT Cute satellite*, TOKYO UNIVERSITY, 2002. <http://horse.mes.titech.ac.jp/srtlssp/cubesat/index.html>.
- [9] us navy, *Book 10* (<http://www.tpub.com/neets/book10/index.htm>), us navy, 2002.
- [10] Wood and Douglas ltd, *SX450A*, Wood and Douglas ltd, 1998.
- [11] Jim Zyren and Al Petrick, *Tutorial on Basic Link Budget Analysis*, Intersil, 1998.